

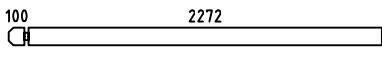

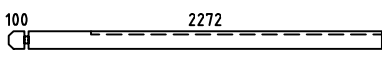





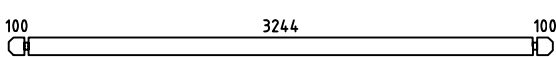
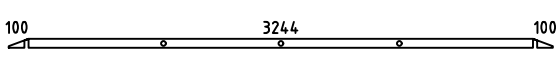
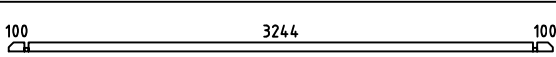
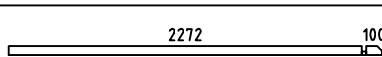
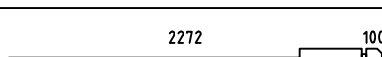
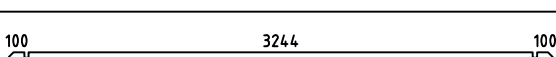
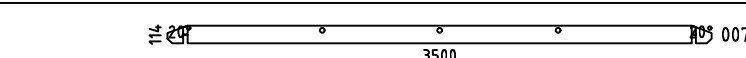
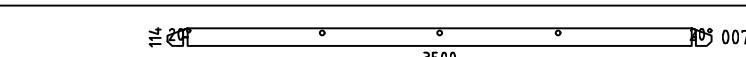
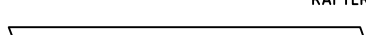
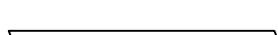

Mitch28

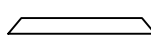
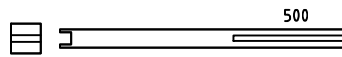
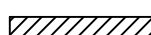
Pos	Specification-Spezifikation-Specificatie	St.	Profile (mm)	Length (mm)
001		6	28x114	2400
002		1	28x114	2400
003		25	28x114	528
004		36	28x114	3500
005		2	28x57	3500
006		1	28x57	3500
008		1	28x57	2400
009		1	28x114	2400
010		1	28x114	3500
WA-1		1		
WB-1		1		
SR1	RAFTER-DACHSPARREN-DAKSPAR 	4	44x70	2355
SR2	RAFTER-DACHSPARREN-DAKSPAR 	4	44x70	1729
SR3	RAFTER-DACHSPARREN-DAKSPAR 	4	44x70	1221
	Diagonal for POST 85x85 	4		500
	-POST 85x85 	2		1983
	Eave Board-Traubret-Dakranden board 	4	18x70	3750
HS1	Handrail-Handlauf 	2		1820
	Storm Brace-Sturmleiste 	3	18x40	2000
	Uprofiil2 	2		1562
DE3	Roof Panel 3-Dach Elemente 3-Dakpanelen 3 	4+4	1966x495	
DE1	Roof Panel-Dach Elemente-Dakpanelen 	4+4	1445x1347	
	Adjustable foot-Stellfuß+Schrauben 5x40 4stück für Post 	2		
N1	Ridge piece-Firstelement-Nokstuk 	1		
	Screw-Schraube-Schroef 4x60 	160		
Kood	Materjal	File	Mitch28.dwg	Leht 1/2

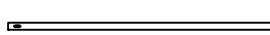
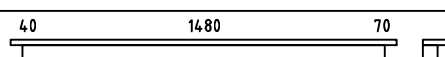
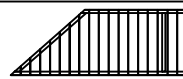
H = 1.500 m
 TOTAL: 10.52 m²

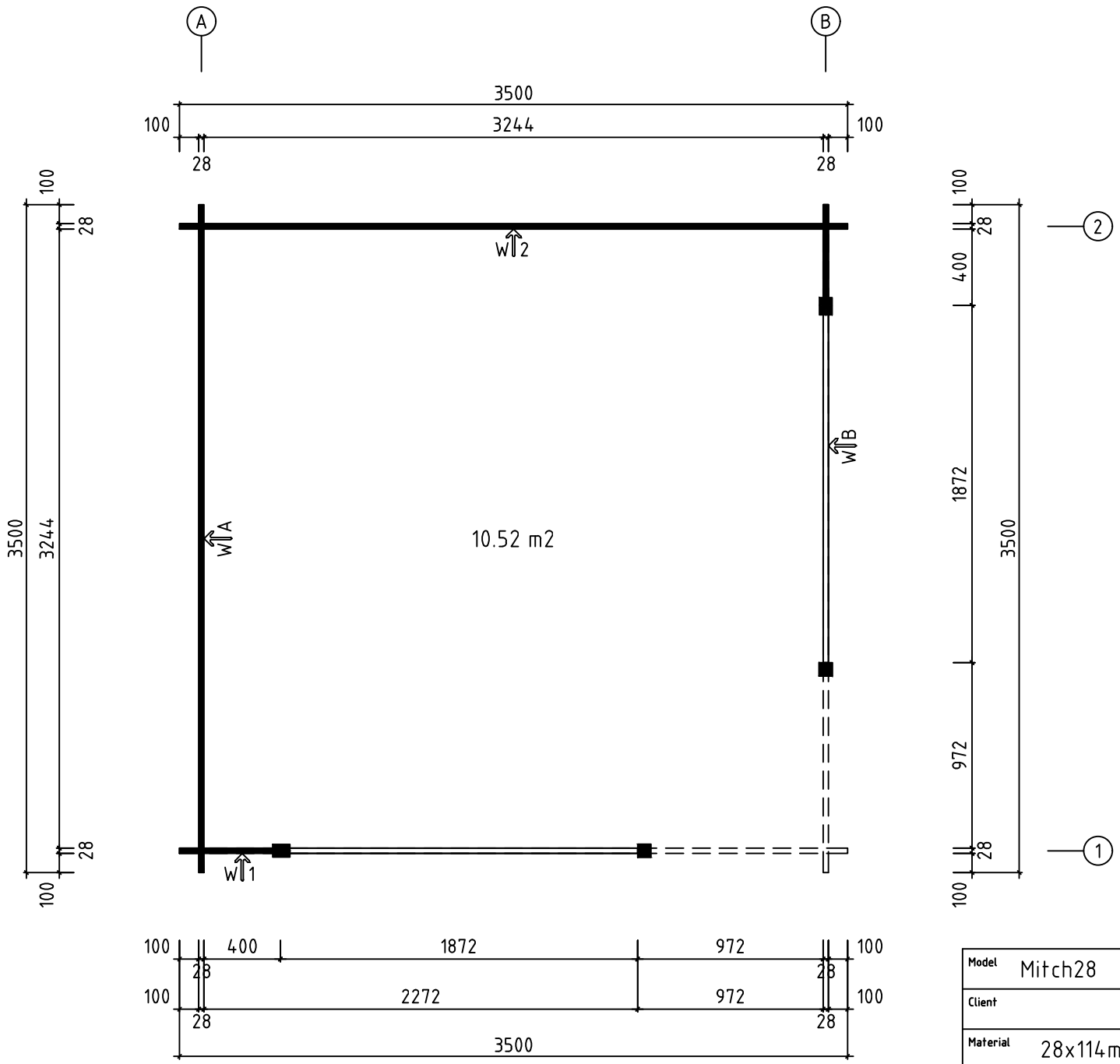

Model	Mitch28	Page	PLAN
Client		Scale	1:30
Material	28x114mm	Date	17.08.2021
Company		File	Mitch28.dwg

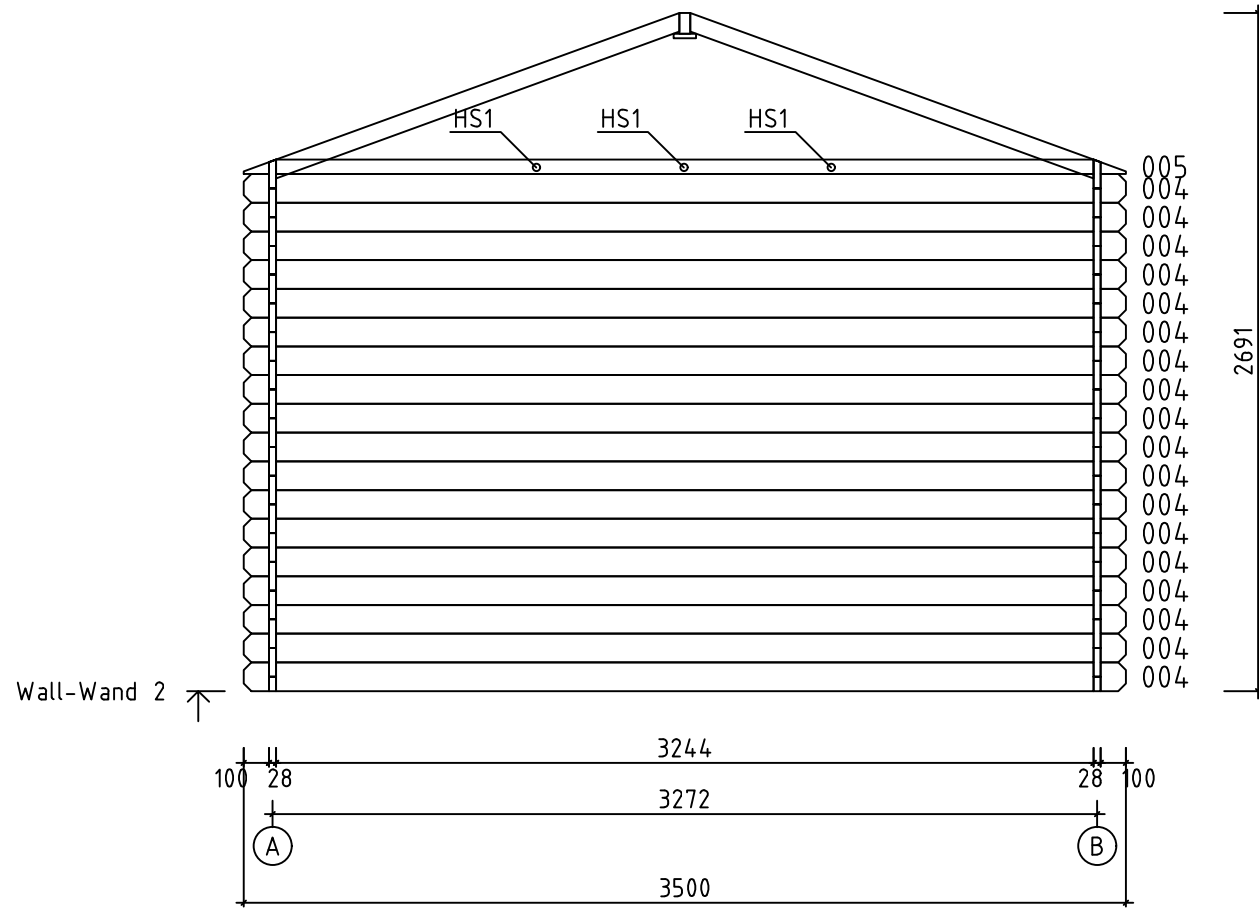

Model	Mitch28	Page	5
Client		Scale	1:30
Material	2.8x11.4	Date	17.08.2021
Company		File	Mitch28.dwg

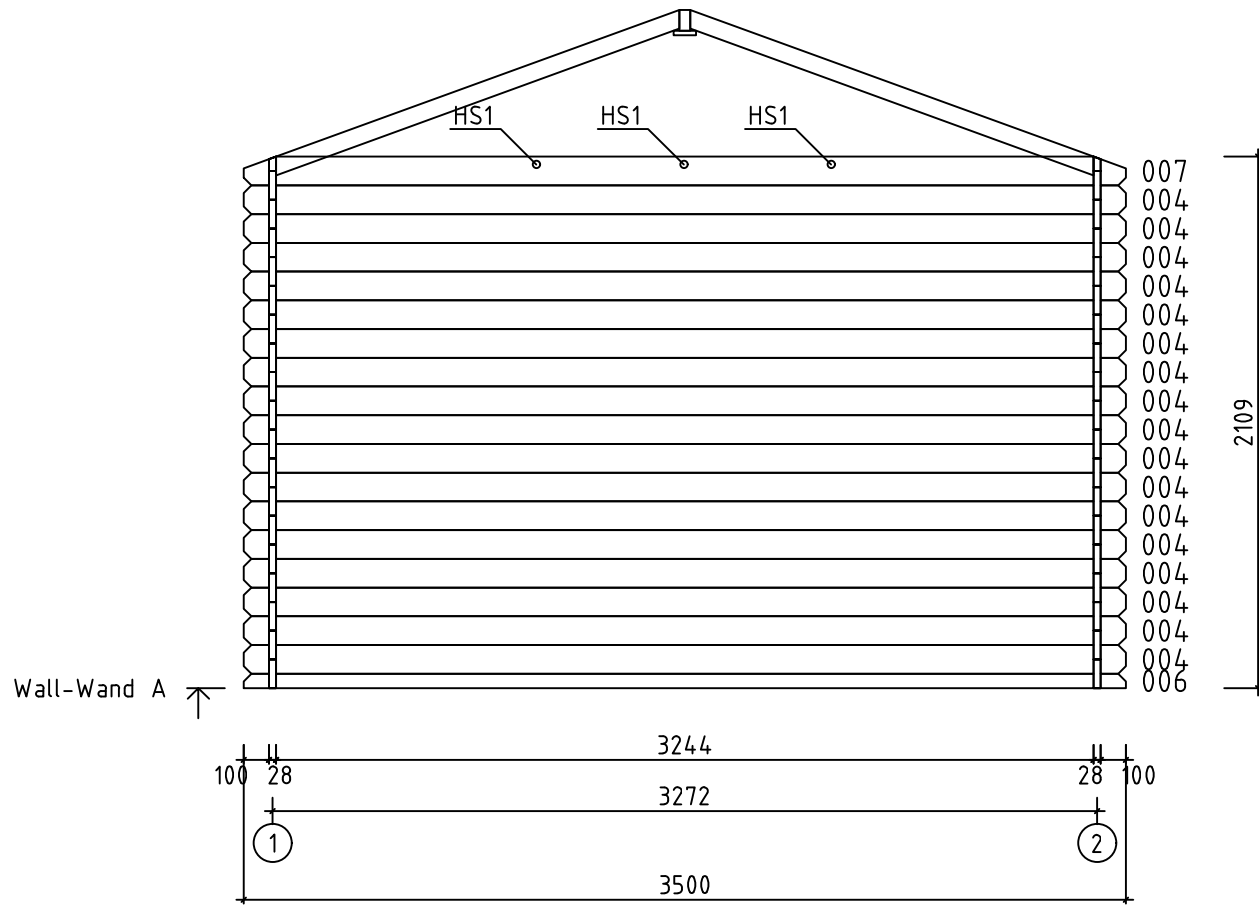

Model	Mitch28	Page	2
Client		Scale	1:30
Material	2.8x11.4	Date	17.08.2021
Company		File	Mitch28.dwg

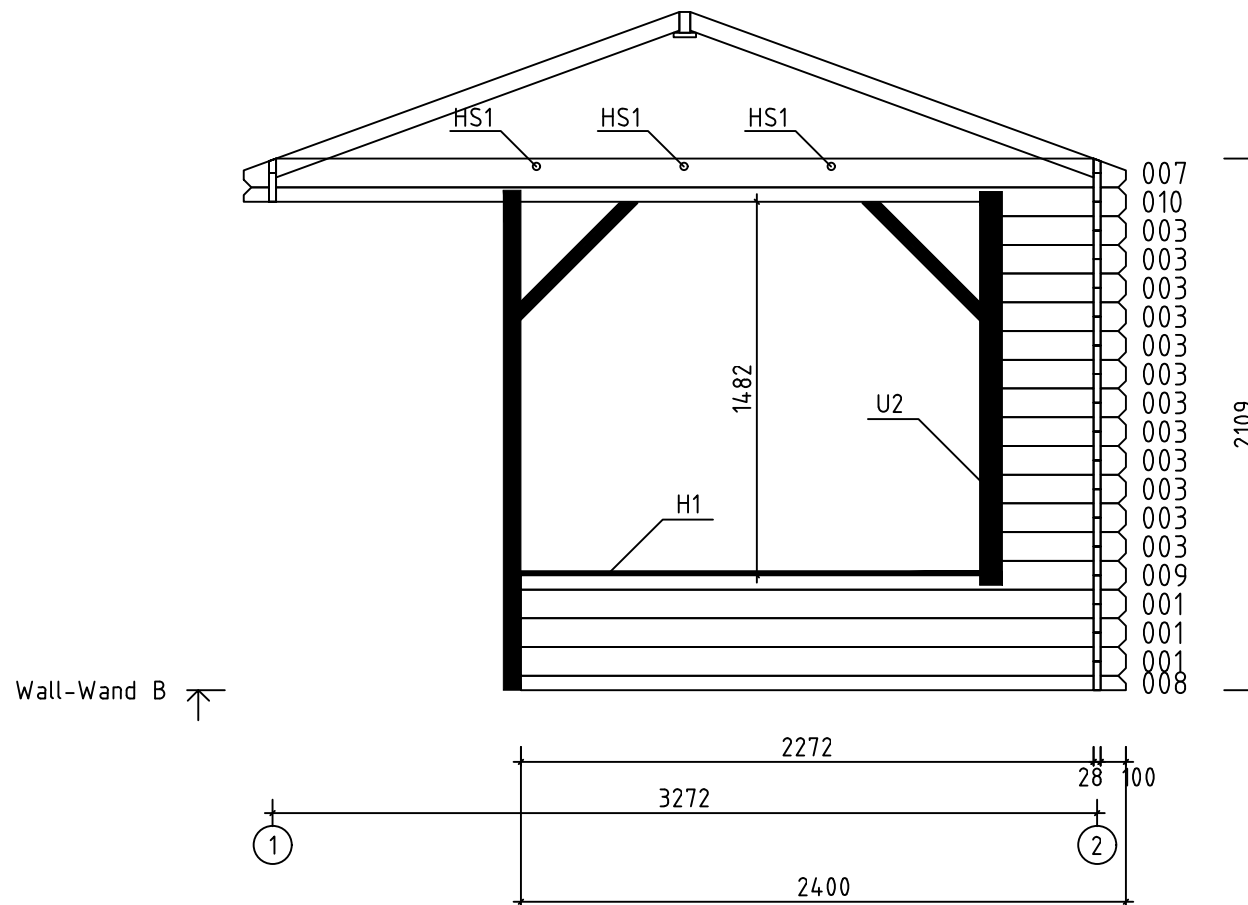

Model	Mitch28	Page	3
Client		Scale	1:30
Material	2.8x11.4	Date	17.08.2021
Company		File	Mitch28.dwg

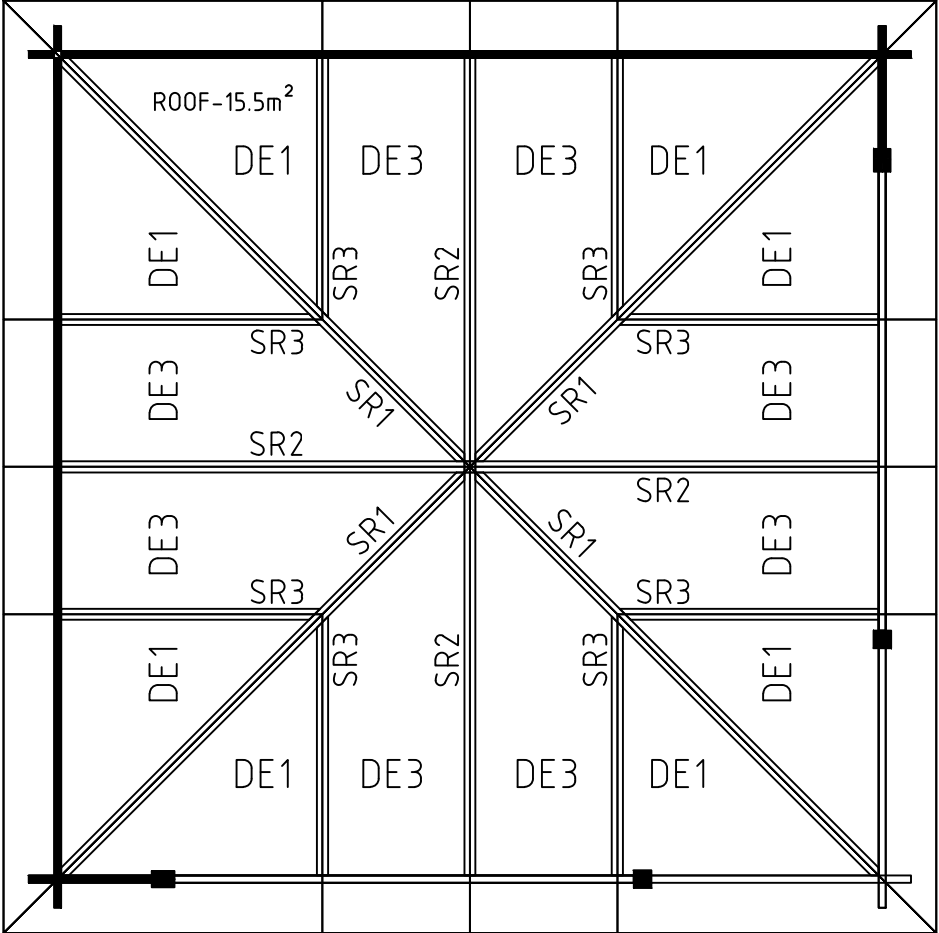

Model	Mitch28	Page	ROOF
Client		Scale	1:30
Material	28x114mm	Date	17.08.2021
Company		File	Mitch28.dwg

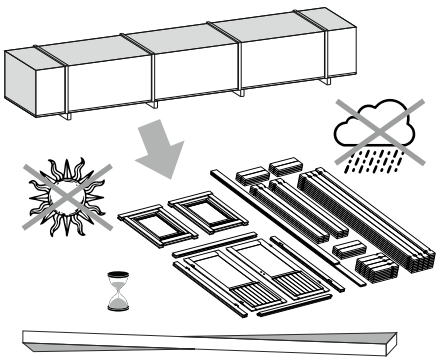

The guide is illustrative. This guide is not project specification.
 Der Leitfaden ist illustrativ. Dieser Leitfaden ist keine Projektspezifikation.
 De gids is illustratief. Deze gids is geen projectspecificatie.

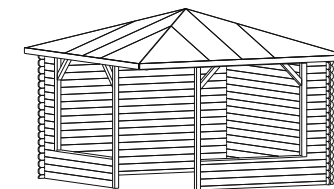

1.

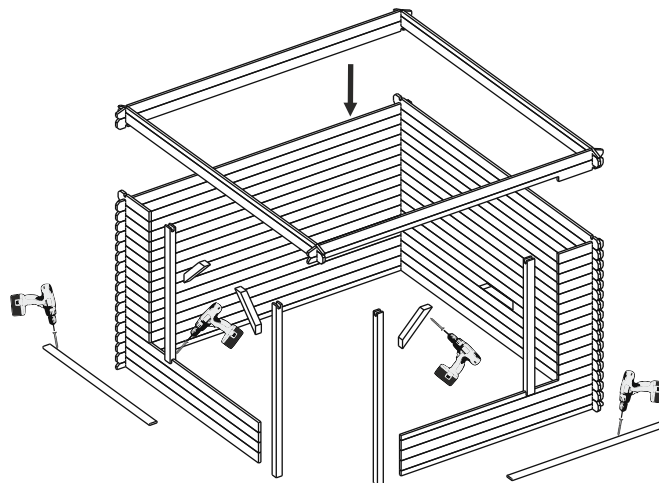
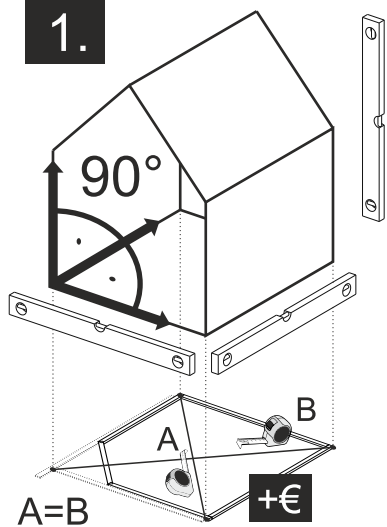

2.

OPTIONS- STORM BRACES

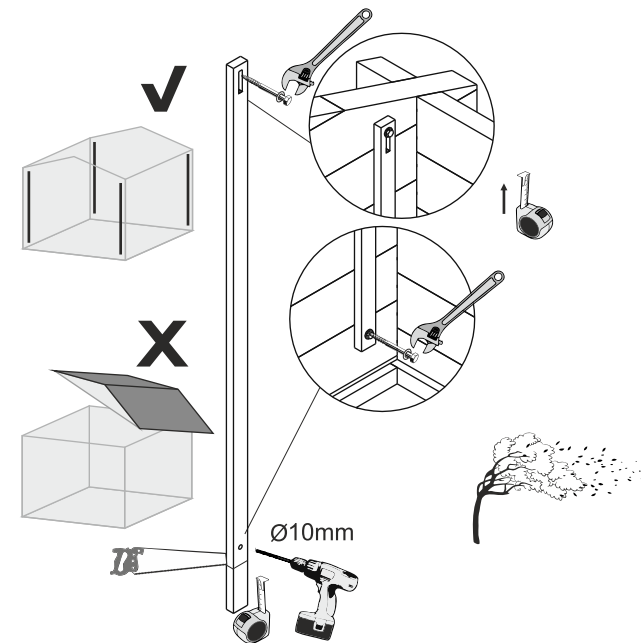

NB!

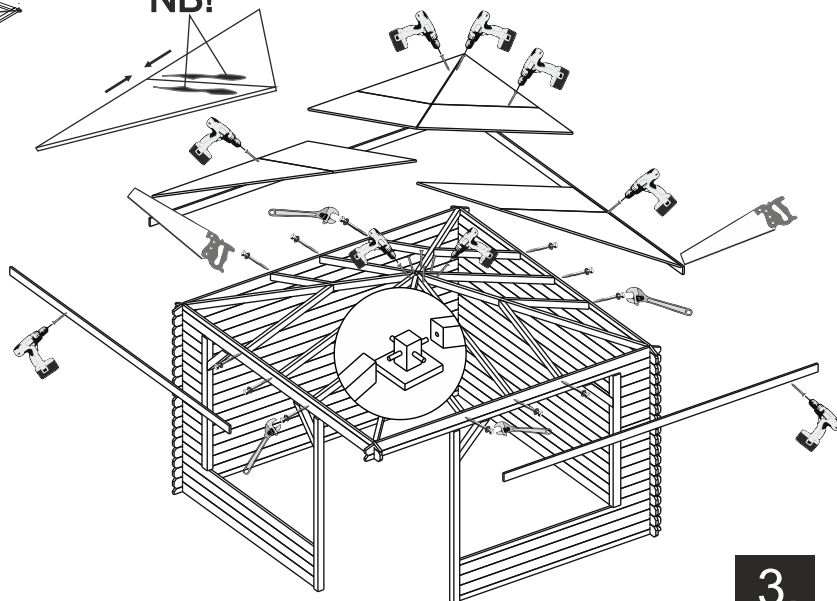

3.

