

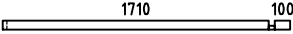

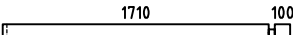

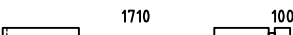





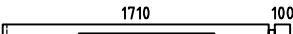
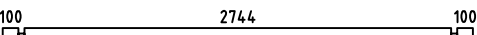
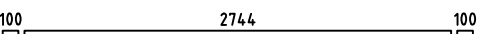
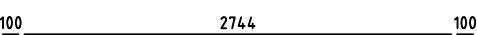
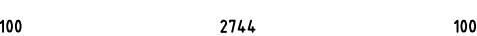
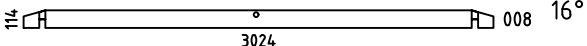
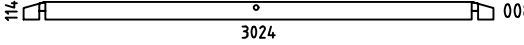
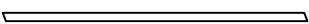



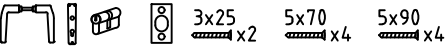



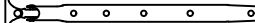

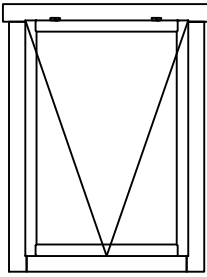
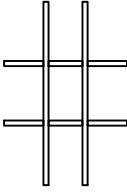
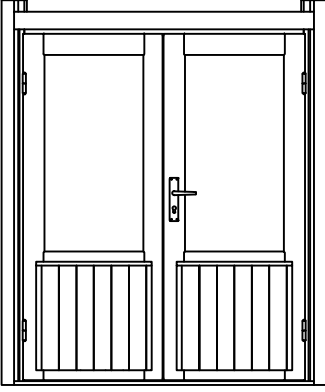
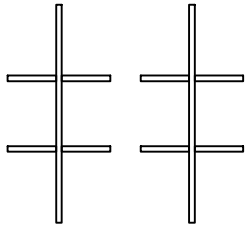
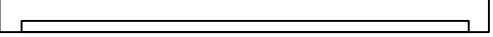

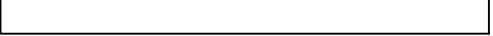
Emma 40 ISO

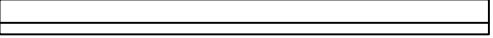
Pos	Specification-Spezifikation-Specificatie	St.	Profile (mm)	Length (mm)
001		1	40x57	1850
002		10	40x114	1850
003		1	40x114	1850
004		21	40x114	490
005		21	40x114	490
006		1	40x114	1850
007		1	40x114	3024
009		1	40x57	3024
010		36	40x114	3024
011		2	40x57	3024
W1-1		1		
W2-1		1		
SR2	RAFTER-DACHSPARREN-DAKSPAR 	4	44x55	1960
SR1	RAFTER-DACHSPARREN-DAKSPAR 	4	44x55	1420
L-1	Eave Slat-Traufenleiste-Afdekljst 	4	40x18	3250
PE1	Ceiling Element-Deckenelement-Plafond Element 1 	1	931x1316	
	Double Door Set ISO-Doppeltür Satz-Dubbele Deur Set 	1		
	Nail-Nagel-Spijker 1.2x20 	35	1.2x20	
N1	Ridge piece-Firstelement-Nokstuk 	1		
DE1	Roof Panel-Dach Elemente-Dakpanelen 	4+4	1620x1560	
WS1	Window Stay-Fensterfeststelle 	2		
HS1	Wood Bolt set-Holzschraubesatz-Hout Bout 8x80 	4		
Kood	Materjal	File	Emma40 TD ISO.dwg	Leht 1/2

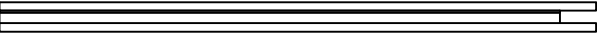
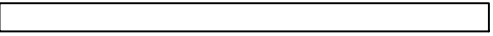
Pos	Specification-Spezifikation-Specificatie			St.	Profile (mm)	Length (mm)
W9N 86 .5x122 .5 ISO	<p style="text-align: center;">WINDOW 865x1225 ISO</p> <div style="display: flex; justify-content: space-around; align-items: center;">  <div style="text-align: center;"> <p>Window Glazing Bar Fenstersprossen Raamroeden</p>  </div> </div>			2		
	DD6P 141 .5x184	<p style="text-align: center;">DOOR 1415x1840 ISO</p> <div style="display: flex; justify-content: space-around; align-items: center;">  <div style="text-align: center;"> <p>Door Glazing Bar Türsprossen Deuroeiden</p>  </div> </div>			1	
CORNER DOOR SET						
1	Top Jamb			1	58x40	1415
2	Threshold			1	58x40	1415
3-4	Vertical Jamb			2	58x40	1840
5-6	Post Set			1+1	42x61	1970
7-8	Cover Slat			2	40x18	1810
9-10	Casting			2	18x95	1500
	Screw-Schraube-Schroef 4x60			16		
	Screw-Schraube-Schroef 5x90			16		
Kood	Materjal			File	Emma40 TD ISO.dwg	Leht 2/2

H = 1.200 m
 TOTAL: 7.00 m²

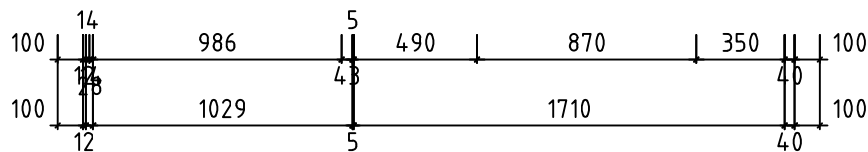
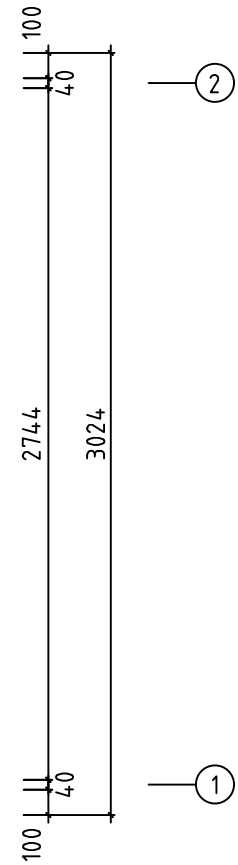
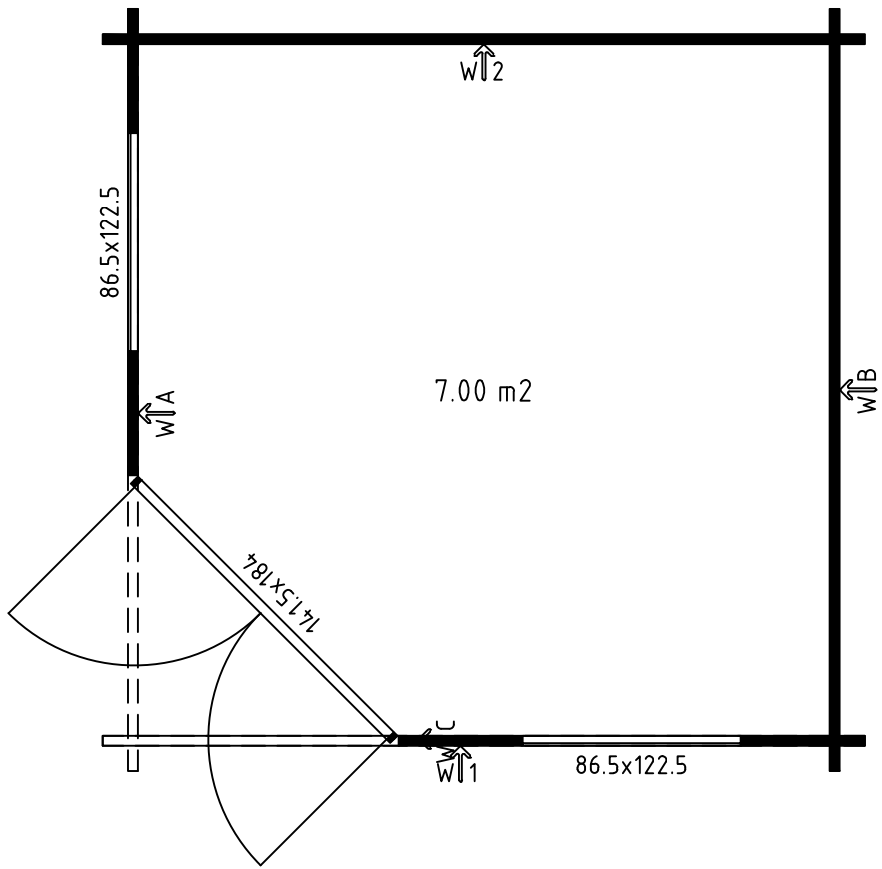
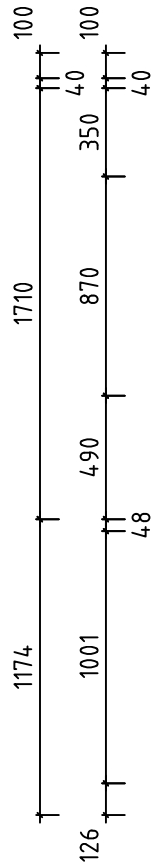
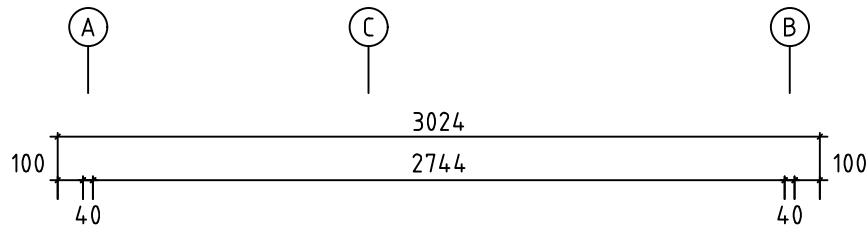

Model	Emma40 TD ISO	Page	PLAN
Client		Scale	1:30
Material		Date	20.11.2018
Company		File	Emma40 TD ISO.dwg

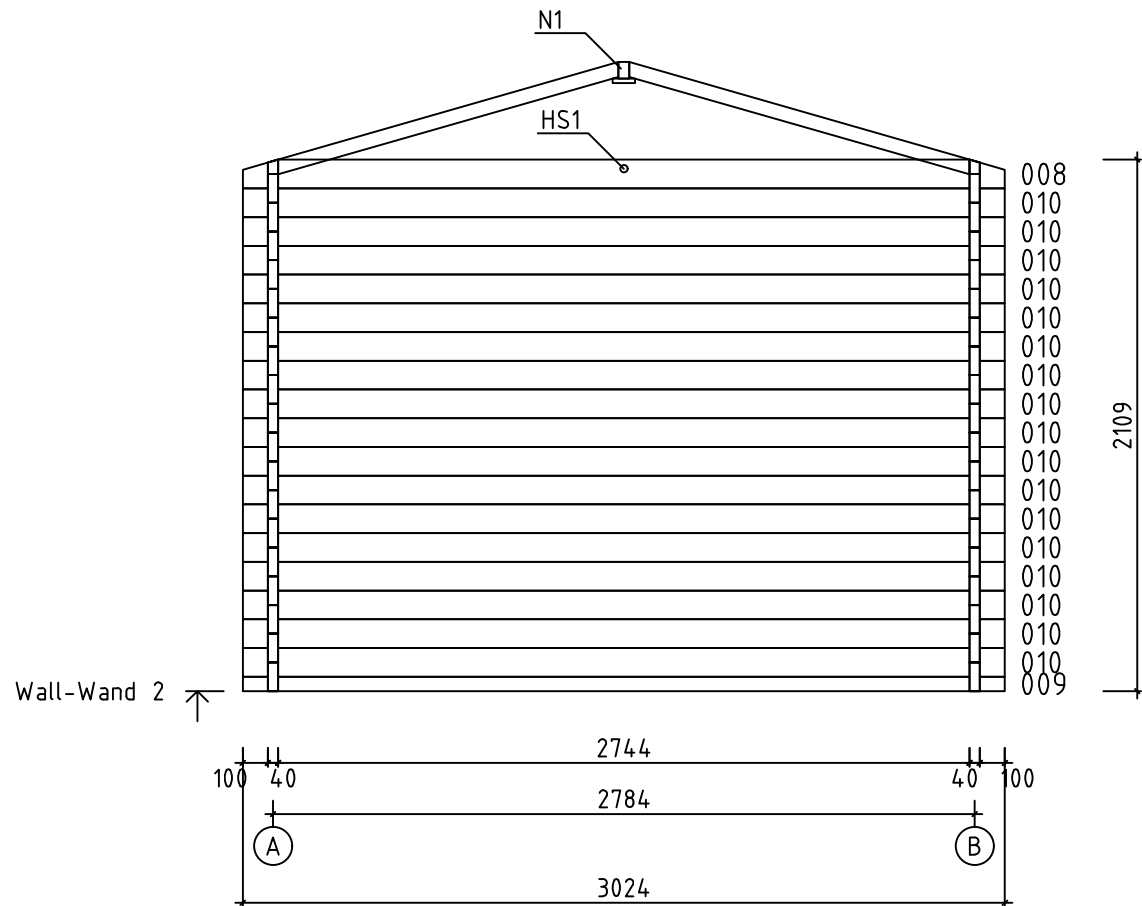

Model	Emma40 TD ISO	Page	6
Client		Scale	1:30
Material	4x11.4	Date	20.11.2018
Company		File	Emma40 TD ISO.dwg

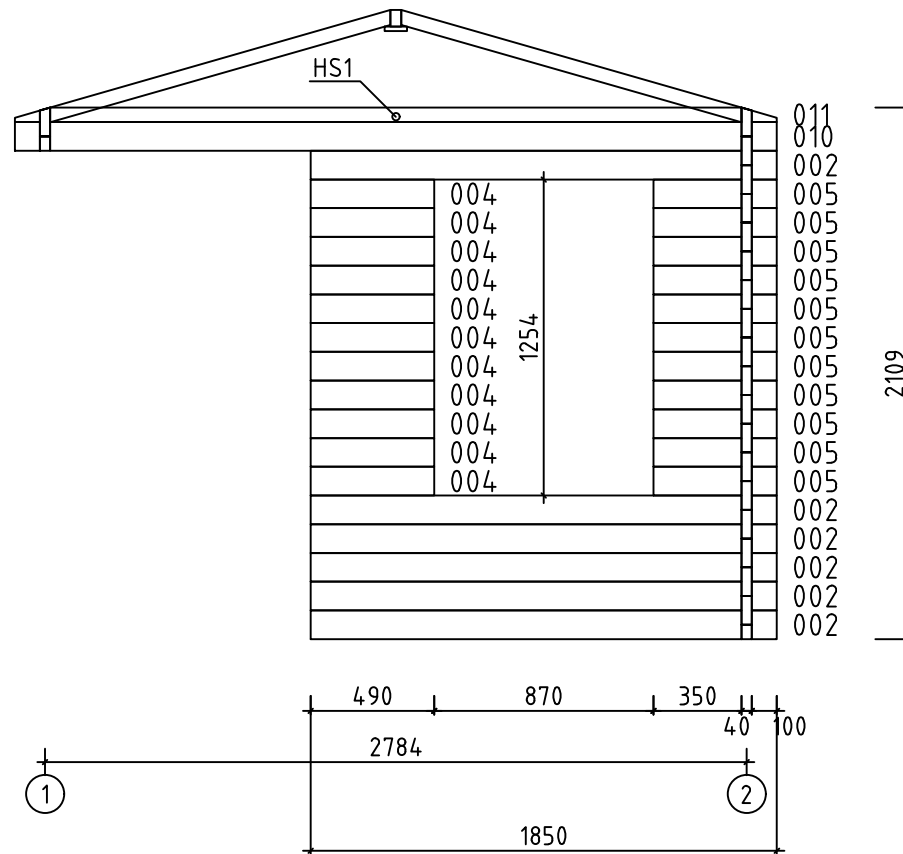

Model	Emma40 TD ISO	Page	2
Client		Scale	1:30
Material	4x11.4	Date	20.11.2018
Company		File	Emma40 TD ISO.dwg

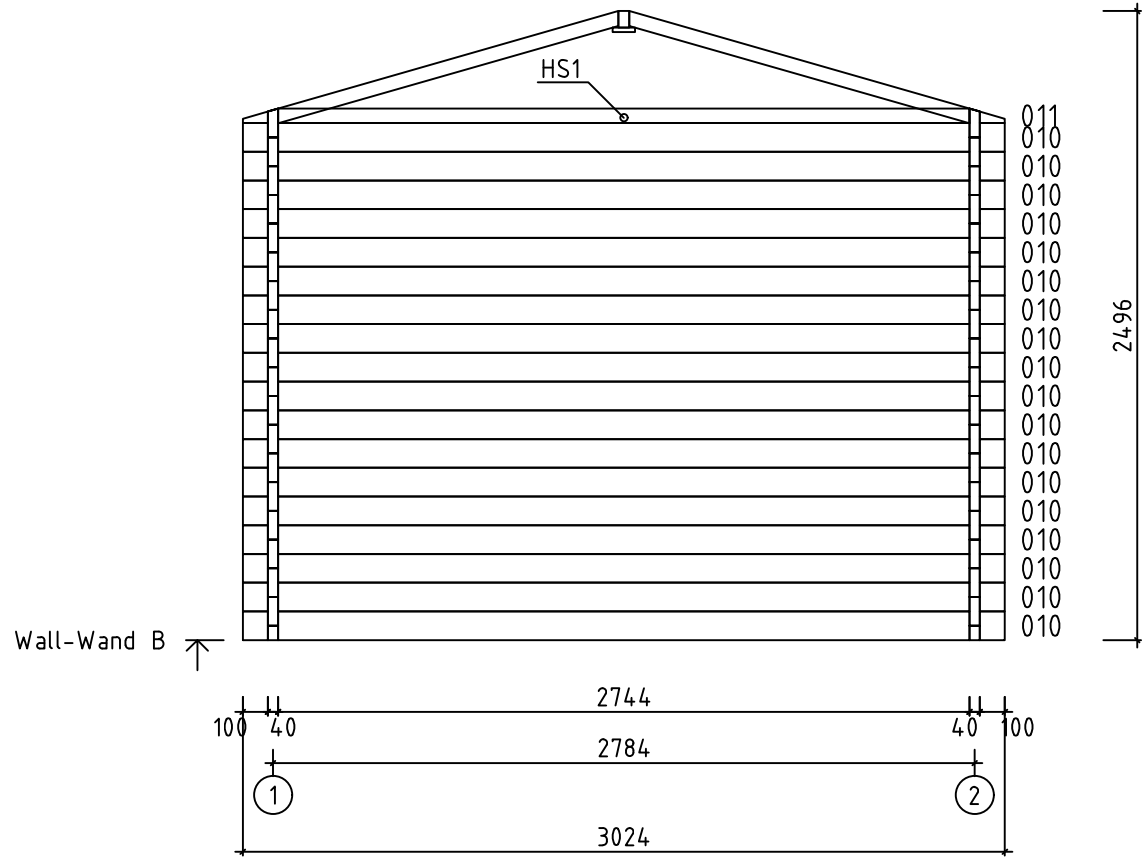

Model	Emma40 TD ISO	Page	3
Client		Scale	1:30
Material	4x11.4	Date	20.11.2018
Company		File	Emma40 TD ISO.dwg

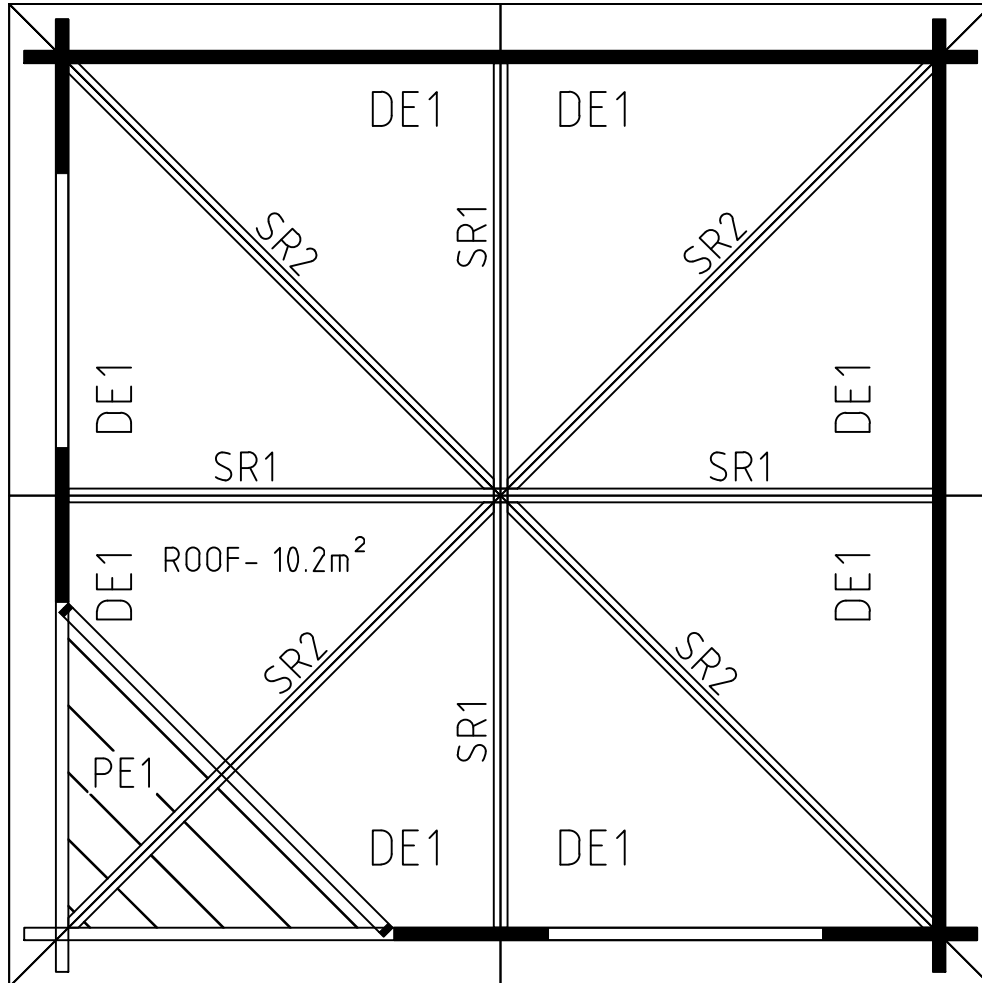

Model	Emma40 TD ISO	Page	ROOF
Client		Scale	1:30
Material		Date	20.11.2018
Company		File	Emma40 TD ISO.dwg

The guide is illustrative. This guide is not project specification.
Der Leitfaden ist illustrativ. Dieser Leitfaden ist keine Projektspezifikation.
De gids is illustratief. Deze gids is geen projectspecificatie.

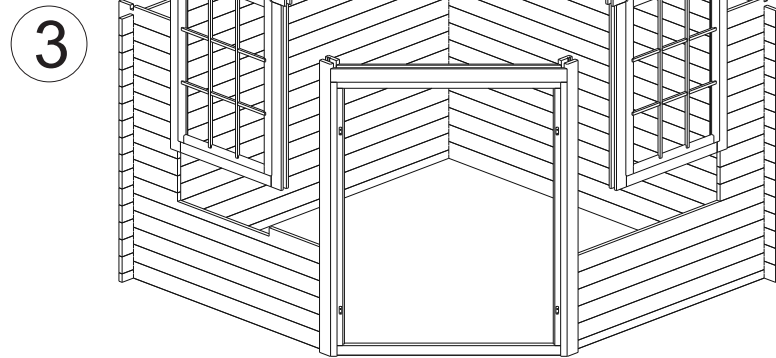
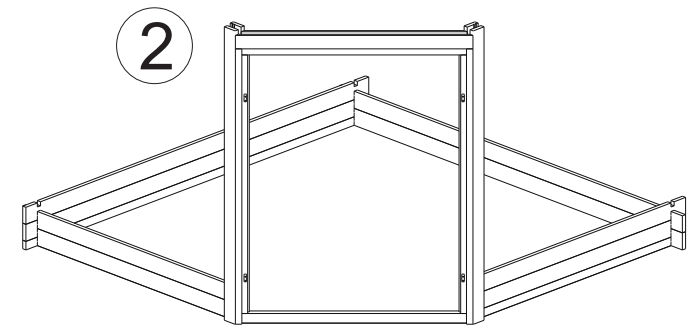
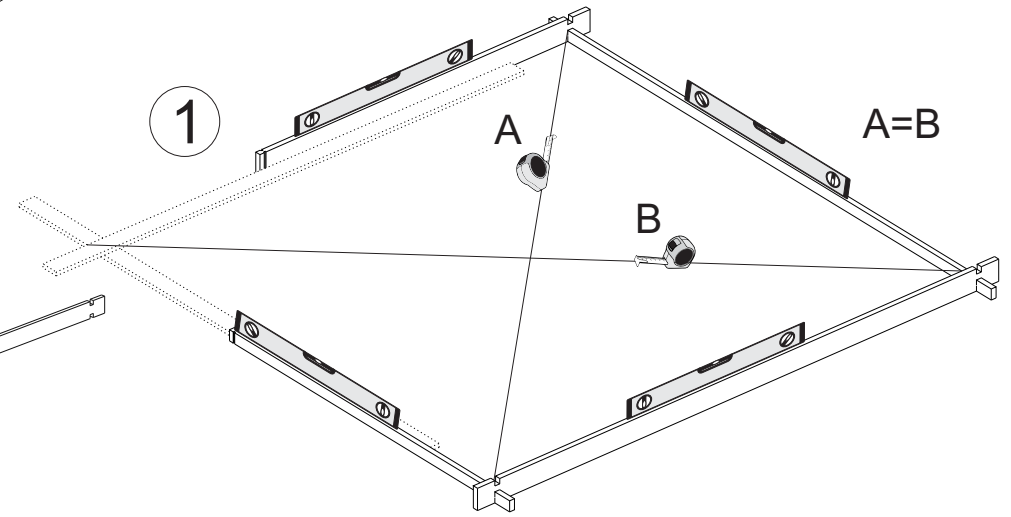
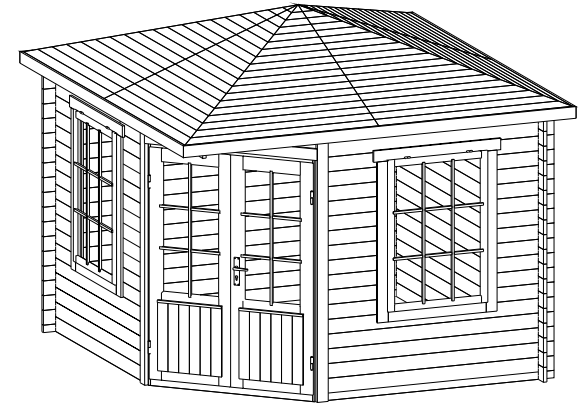
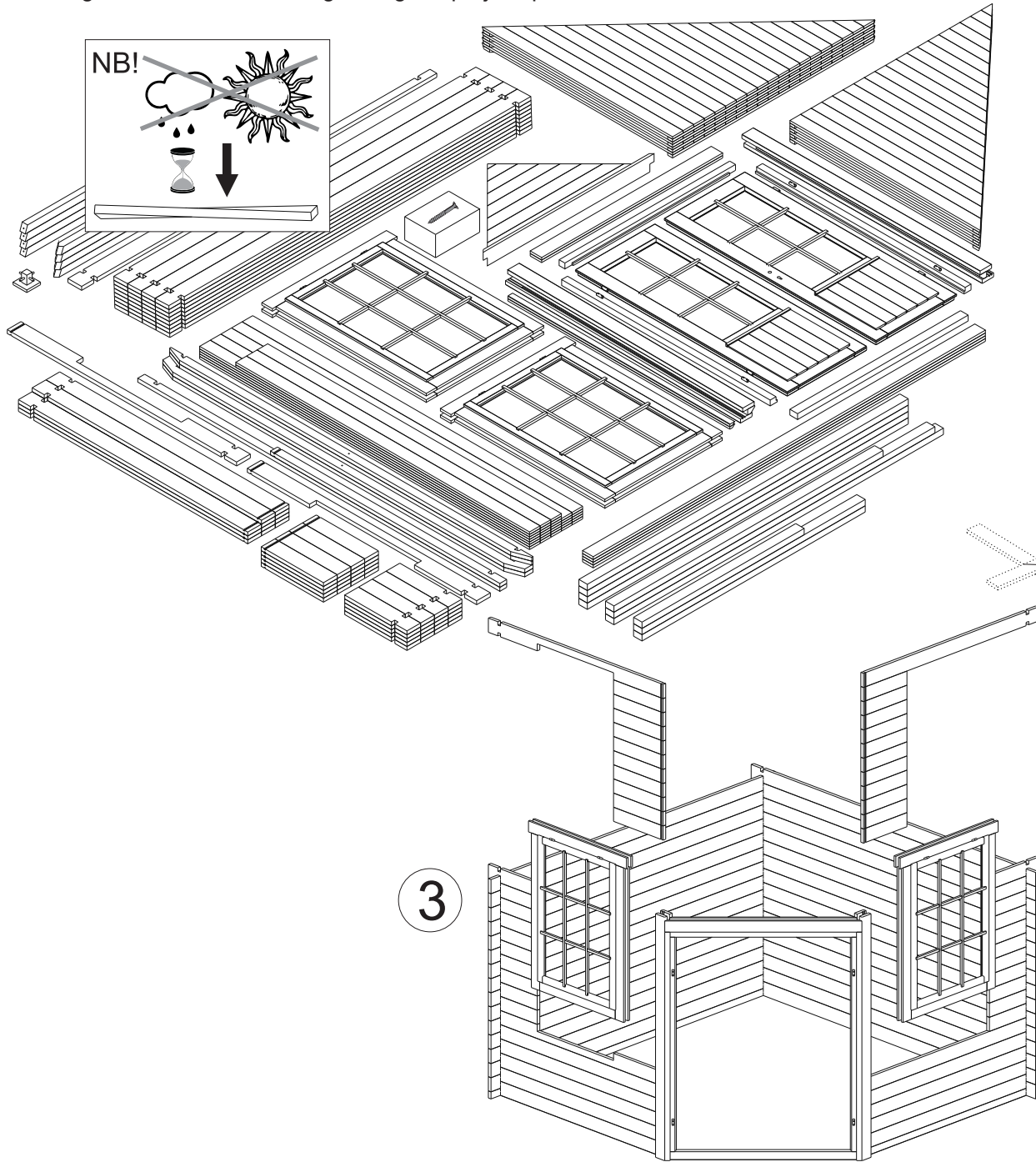

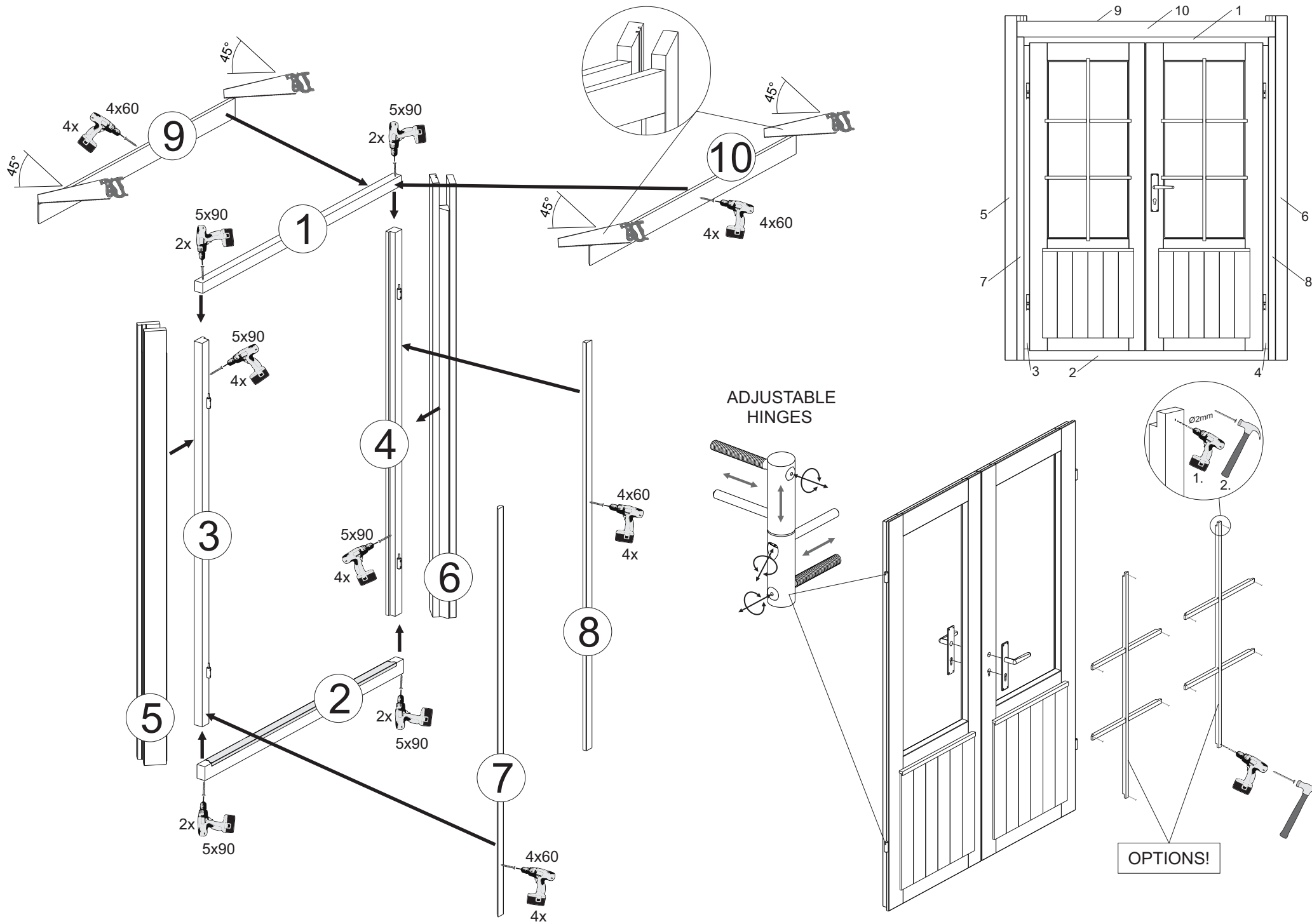

4

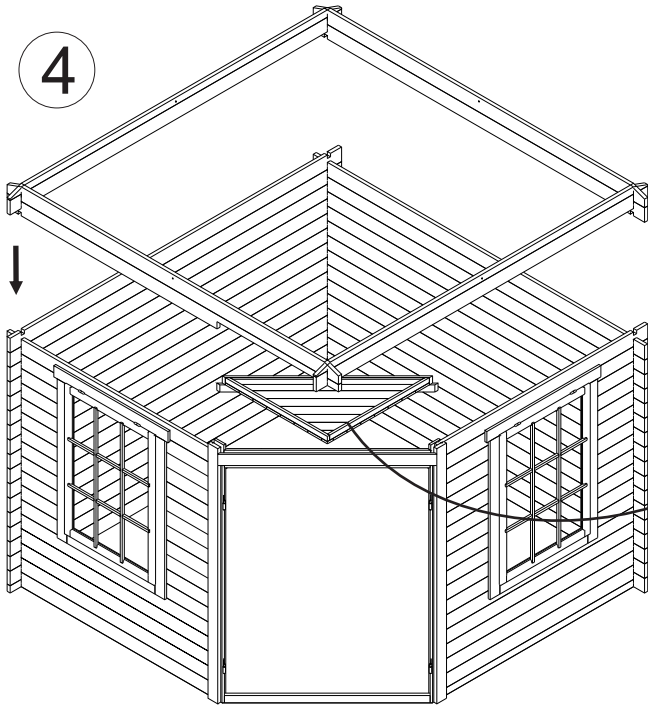

5

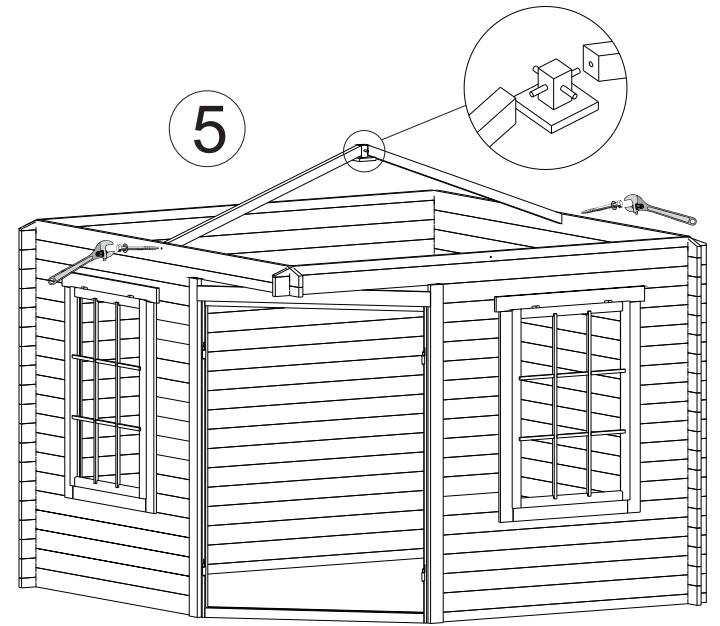

6

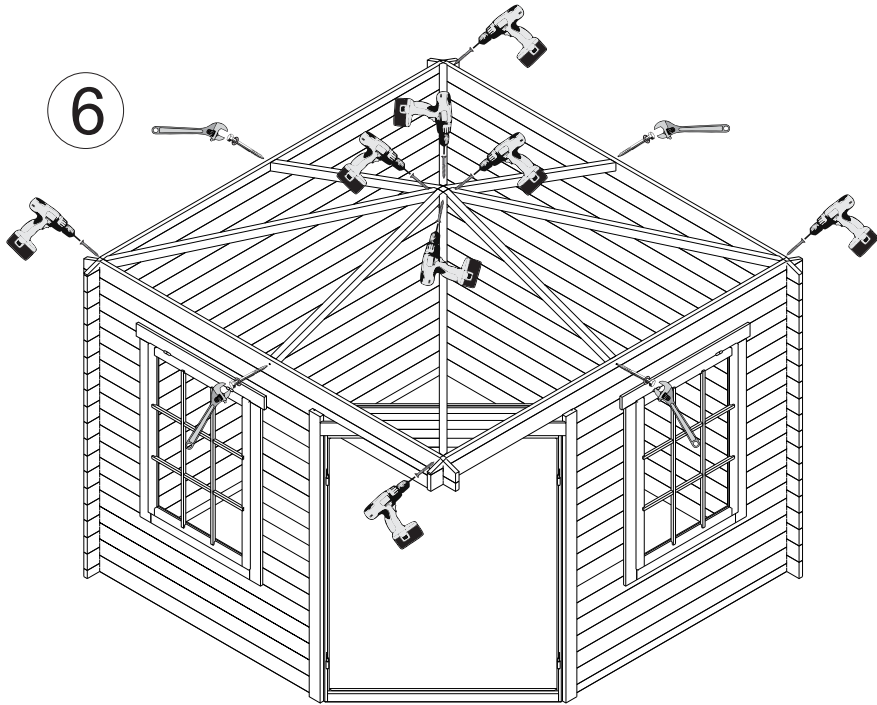

7

